

Air conditioner

Installation manual

Modbus Interface Module MIM-B19N

- Thank you for purchasing this Samsung product.
- Before operating this unit, please read this Installation manual carefully and retain it for future reference.



SAMSUNG

Contents

Safety Information	3
Safety Information	3
Installation	5
Installing the Modbus Interface Module	5
Modbus interface module	
About Modbus Interface module	
Communication sequence	
Checking Operation	11
LED indication	
7-SEGMENT indication	
Notes on interface module installation	
Setting the address using the DIP and rotary switches	
Modbus Register Table	13

Safety Information





This installation manual explains how to install a Modbus interface module that connects both the outdoor unit and the ventilation system of the Samsung air conditioner to the Modbus system. Please read this manual thoroughly before installing the product. (Please refer to an appropriate installation manual for any optional product installation.)

WARNING

Hazards or unsafe practices that may result in severe personal injury or death.

CAUTION

Hazards or unsafe practices that may result in minor personal injury or property damage.

-  Must follow directions.
-  Do NOT attempt.
-  Make sure the machine is grounded to prevent electric shock.
-  Unplug the power plug from the wall socket.
-  Do NOT disassemble.

FOR INSTALLATION

WARNING

-  **Contact a service center for installation.**
 - Failure to do so may result in product malfunction, water leakage, electric shock and fire.

You must use the supplied wire for installation.

- Failure to do so may result in fire or damage to an Modbus interface module.

All electric works should comply with local regulations and installation work carried out by a qualified technician.

- Installation by an unqualified technician may result in product malfunction, electric shock, and fire.

Check whether the installation work is performed in accordance with the installation instructions.

- Incorrect installation of an Modbus interface module may result in electric shock or fire.

Safety Information

FOR INSTALLATION

CAUTION

-  When connecting a wire, do not tighten it too much.
 - Failure to do so may result in breakage of the wire.

Make sure the Modbus interface module installation doesn't cause interference with other electrical appliances, particularly in a hospital etc.

- Failure to do so may result in abnormal operation.

-  Do not install the product in an area where combustible gas leaks or possible gas leakage is expected.
 - Failure to do so may result in breakage of the wire.

Do not install the product in conditions where it is exposed to oil, steam etc.

- Use of the product in an area exposed to oil, steam, sulfuric acid gas etc may result in component damage or product malfunction.

Do not install the product in a place where acid or alkali liquid or special sprays are used.

- Failure to do so may result in electric shock or abnormal operation.

FOR OPERATION

WARNING

-  Do not remodel or repair the Modbus interface module yourself.
 - Failure to do so may result in product malfunction, electric shock and fire, so contact a service center for repair.

When disposing of an Modbus interface module, contact a service center.

-  Do not move or reinstall an installed Modbus interface module yourself.
 - Failure to do so may result in electric shock or fire.

FOR OPERATION

CAUTION







-  Make sure that water does not permeate inside the Modbus interface module.
 - Failure to do so may result in electric shock or fire.

-  Do not connect power cable to the control cable terminal.
 - Failure to do so may result in fire.

Installing the Modbus Interface Module

Modbus interface module

Product and components

Name	Interface module	DC power cable (12 V)	Communication cable	Case		Cable tie
Shape						

Connecting the Modbus interface module to the DVM

- 1 After attaching a case to the side of the outdoor unit's electric equipment section, install the Modbus Interface Module.
 - 2 Connect the power cable and communication cable of the Modbus Interface Module.
- When a Modbus interface module is installed, you can perform a centralised control of all indoor units connected to an outdoor unit.

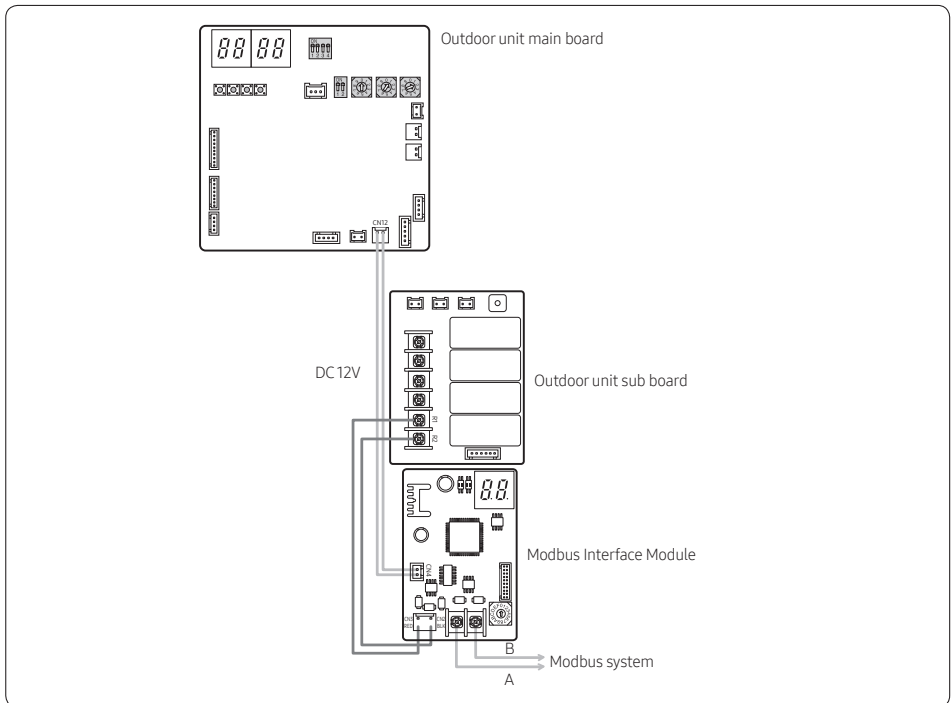

Installing the Modbus Interface Module



CAUTION

- You should switch off the power supply and disconnect the power cable.
(Abnormal operation of the product may occur due to the electric problem.)
- 3** Set the address of the Modbus interface module.
- The addresses of all Modbus interface modules must be different each other. (Setting range: 1 to 247)
 - Make sure that the indoor unit addresses are in the range 0 to 47.
 - If you set an out-of-range address, it is not recognized and the tracking error (E604) occurs.
 - After changing the indoor unit settings (address, 'Use of central control' option), the interface module must be reset.
 - When connecting a 485 communication cable between the Modbus interface module and the BMS, be sure to match the polarity. If the polarity does not match, communication is impossible.
- 4** Set the 'Use of central control' option for indoor units.
- Centralised control and monitoring of indoor units are available only when their "Use of central control" options (SEG5) are set to "Use (1)".
 - If the "Use of central control" options (SEG5) of all indoor units are set to "Disuse (0)", the tracking error (E604) occurs.



CAUTION

- Both distances from the Modbus master to the first and last Modbus interface modules must be within 1000 m.
- You should switch off the power supply before installation.
- The wiring should be installed in accordance with electric wiring regulations and should be placed inside the wall so that users cannot touch them.

Example of Modbus interface module installation

You can connect up to 4 outdoor units (1 main, 3 subs) and 48 indoor units to each Modbus interface module.

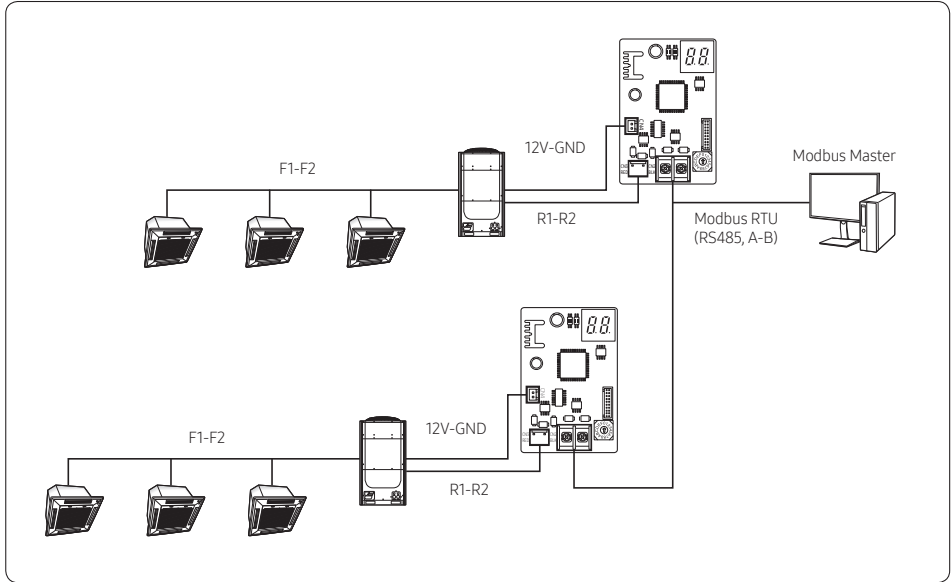

Installing the Modbus Interface Module

About Modbus Interface module

Specifications	Unit connection protocol	Samsung Control Layer Protocol (R1/R2)
	Maximum number of connectable units	1 outdoor unit (4 outdoor units including sub units in the case of modular installation) and 48 indoor units
	Modbus interface module address range	1 to 247
	BMS unit protocol	Modbus RS485 (2 wires, max. 1000 m)
	operating temperature range	-10 to 50°C
	Power	DC 12V
Modbus communication	Communication protocol	Modbus RTU EIA485
	Device type	Slave
	Byte order	Big endian. Every point's value is encoded in 2 byte registers (even if its possible values are 0 and 1). Each value is expressed in MSB. LSB format (big endian).
	Settings	<ul style="list-style-type: none"> • Baud rate: 9600 bps • Data bits: 8 • Stop bit: 1 • Parity: Even
	Supported Modbus function codes	<p>Read functions:</p> <ul style="list-style-type: none"> • 3 read holding registers • 4 read input registers <p>Write functions:</p> <ul style="list-style-type: none"> • 6 write single registers • 16 write multiple holding registers <p>※ Other function codes are treated as illegal functions and return an exception response.</p> <p>※ If poll records are used to read/write multiple records, the range of addresses requested must contain valid addresses, otherwise the corresponding Modbus error code is responded.</p>

Communication sequence

System Initialization

- At start-up, all registers have the value 0.
- When the tracking of the Modbus interface module is completed, bits 0 to 2 of the communication status register (register 1) for each indoor unit are updated to 1.
- If all bits 0 to 2 of register 1 are 1 even for one indoor unit, it means that the tracking of all indoor and outdoor units has been completed, and that all indoor and outdoor register values have been updated.
- If bit 0 of the communication status register for an indoor unit is 0, it means that this indoor unit is not connected.
- After the power is turned on, the BMS periodically reads the communication status register values of indoor units. Then, if an indoor unit with all bits 0 to 2 of the register set to 1 is found, control and monitoring are available for the found indoor unit from that time.
- The BMS can only control the indoor units with all bits 0 to 2 of the communication status register for the indoor unit set to 1.

Monitor and operate units from the BMS

- When the BMS writes a value to the holding register, a control command is sent to the relevant indoor unit.
- The holding register value for an indoor unit is not updated until a changed status value is received from that indoor unit.
- Because the user might be able to operate indoor units with a remote control, the BMS must read their status periodically.
- If communication between an indoor/outdoor unit and the Modbus interface module is stopped, the last status value is retained until communication is resumed.

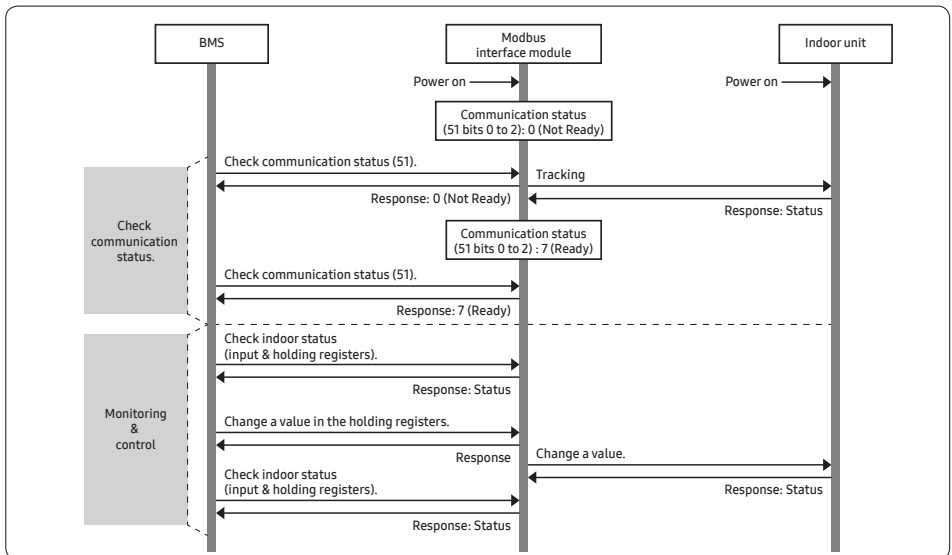

Installing the Modbus Interface Module

⚠ CAUTION

- Note that when the Write Single Register or Write Multiple Registers command is received for all holding registers (see Table 2. Modbus Register Table) from the Modbus master, the Modbus interface module (MIM-B19N) always sends a control command to the indoor units. Therefore, be sure to send a command to the Modbus master only when control (operation on/off, temperature setting, etc.) is required.
- If an identical command is issued consecutively, the same command is repeatedly sent to the indoor units. To check whether the write command operates normally, send a write command to the master and then read the register status.
- When reading from or writing to a register consecutively, be sure to send a command at least 10 ms after the last response is received from the Modbus interface module.

Table 1. Example of signal flow

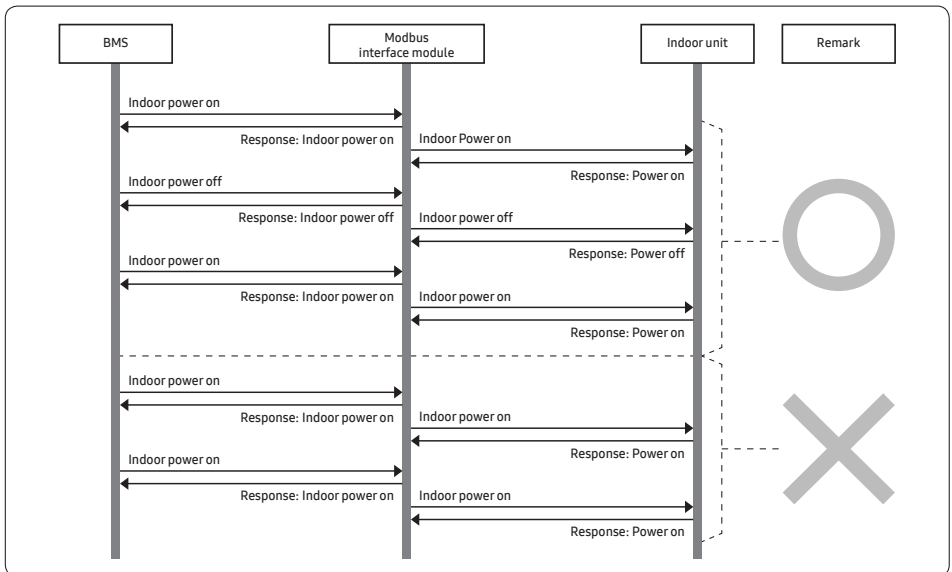

Checking Operation

LED indication

- 1 When communication between the Modbus interface module and an outdoor unit is proceeding, the Y-GRN LED blinks.
- 2 When communication between the Modbus interface module and the BMS is proceeding, the RED LED blinks.

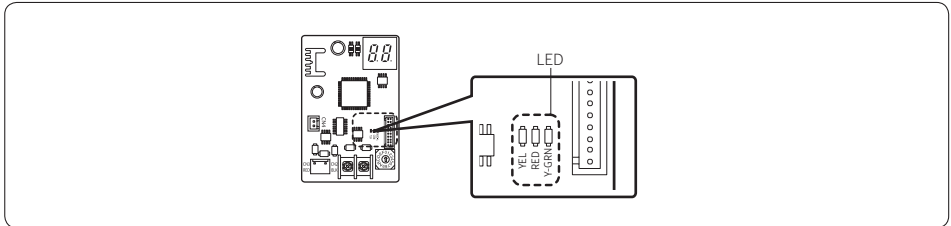

7-SEGMENT indication

- 1 When communication with all indoor and outdoor units is stopped for more than 3 minutes, E6 and 16 continue to be displayed alternately.
- 2 When communication with a specific indoor unit is stopped for more than 3 minutes, E6 and 15 continue to be displayed alternately.
- 3 When the tracking is not completed within 10 minutes after the power is turned on, E6 and 04 continue to be displayed alternately.
- 4 When an EEPROM error occurs, E6 and 54 continue to be displayed alternately.
- 5 When an address error occurs, E6 and 34 continue to be displayed alternately.

Notes on interface module installation

- 1 Each indoor unit address must be set to a value from 00 to 47.
- 2 The address of the Modbus interface module can be set to a value from 1 to 247.
- 3 An air conditioner indoor unit and an energy recovery ventilator (ERV) must not be installed on the same communication line (F1 F2).
- 4 The supported models are the following units that adapt the new communication technology of Samsung: DVM/ CAC indoor unit, hydro kit (low/high temperature), ERV, ERV+, DVM CHILLER, FCU, FCU Kit, and EHS.
- 5 When the Modbus interface module is used, the upper-level controllers of Samsung cannot be connected. For example, the On/Off controllers, Touch centralised controllers, and DMS cannot be used together with the Modbus interface module.

Checking Operation

Setting the address using the DIP and rotary switches

- The address of the Modbus interface module is determined by adding a total of the values of the DIP switches set to ON and the value of the rotary switch.
 Example) Address 57 = 32 + 16 + 9 = SW5 #1 ON value + SW5 #2 ON value + SW1 (rotary switch) value
 Example) Address 147 = 128 + 16 + 3 = SW4 #1 ON value + SW5 #2 ON value + SW1 (rotary switch) value
- The DIP and rotary switches are set only once when the power is turned on. If you have changed the DIP or rotary switch settings, be sure to reset the power.
- The address range for the Modbus interface module is from 1 to 247. If the address is out of range, the error E634 occurs.
- Set the DIP and rotary switches only once at boot time.
- If you have changed the DIP or rotary switch settings, be sure to reset the power.

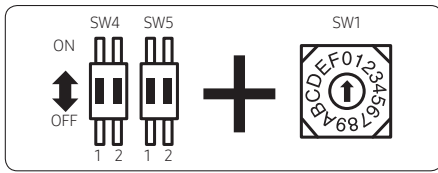

No	Location	Function	ON	OFF
1	SW4-1	Address setting	128	0
2	SW4-2		64	0
3	SW5-1		32	0
4	SW5-2		16	0
5	SW1		0 ~ 15(F)	

Examples of address settings

SW4		SW5		SW1	Address (1 to 247)	
1	2	1	2	0~F	Expression	Result
128	64	32	16	0~15		
0	0	0	0	0	0	NG
0	0	0	0	1	1	1
0	0	0	0	2	2	2
0	0	0	1	3	16+3	19
0	0	1	0	4	32+4	36
0	0	1	1	5	32+16+5	53
0	1	0	1	3	64+16+3	83
1	1	0	0	E	128+64+14	206
1	1	0	1	F	128+64+16+15	223
1	1	1	1	F	128+64+32+16+15	NG
1	0	1	1	A	128+32+16+10	186
1	1	1	0	C	128+64+32+12	236
1	1	1	1	7	128+64+32+16+7	247

Installation

Modbus Register Table

Table 2. Modbus register table

Register No.	Modbus PDU address	Signal description	Signal values	Modbus register type (R/W)								Remarks	
				Indoor	HE/HT/EHS	AHU kit	ERV	ERV+	CHILLER	FCU	FCU kit		
1	0	Modbus interface module error status	b0: Address error b1: Communication error on R1/R2 b2: Tracking error					R					
2	1	Integrated outdoor unit error code	0: No error 100 to 999: Error code					R					
3	2	Outdoor defrost operation	0 or 0xFF: Defrost off Others: Defrost on					R					
4	3	Buzzer on/off	0: Turns the buzzer on 1: Turns the buzzer off					W					
5 to 50	4 to 49	Reserved	-	-	-	-	-	-	-	-	-	-	
$(50 + (IU[0..47] * 50)) + 1$	$(50 + (IU[0..47] * 50)) + 0$	Communication status	b0: Exist b1: Type OK b2: Ready b3: Communication error	R	R	R	R	R	R	R	R	R	
$(50 + (IU[0..47] * 50)) + 2$	$(50 + (IU[0..47] * 50)) + 1$	Unit type:	[Lower Byte] Model code AHU: 90 to 99 ERV: 100 to 102 ERV+: 108 HE: 110 HT: 120 EHS: 115 to 117 Module Chiller: 140 to 149 FCU Kit: 160 to 169 Others: IU	R	R	R	R	R	R	R	R	R	If the upper byte is 10, the FCU is used and the lower byte is ignored. * Unit type examples (Hex) Not defined: 0xFFFF HE: xx6Eh HT: xx78h EHS: xx73h to xx75h
			[Upper Byte] Model group FCU: 10 Others: Ignored										
$(50 + (IU[0..47] * 50)) + 3$	$(50 + (IU[0..47] * 50)) + 2$	Air conditioner on/off	0: Off 1: On Others: Ignored	R/W	R/W	R/W	-	R/W	R/W	R/W	R/W	R/W	

Modbus Register Table

Register No.	Modbus PDU address	Signal description	Signal values	Modbus register type (R/W)							Remarks	
				Indoor	HE/HT/EHS	AHU kit	ERV	ERV+	CHILLER	FCU		FCU kit
(50 + (IU[0.47] * 50)) + 4	(50 + (IU[0.47] * 50)) + 3	Air conditioner mode	0: Auto 1: Cool 2: Dry 3: Fan 4: Heat 21: Cool Storage 24: Heat Storage Others: Ignored ※ 21 and 24 are for the DVM CHILLER's only.	R/W	R/W	R/W	-	R/W	R/W	R/W	R/W	
(50 + (IU[0.47] * 50)) + 5	(50 + (IU[0.47] * 50)) + 4	Indoor fan speed	0: Auto 1: Low 2: Middle 3: High Others: Ignored	R/W	-	-	-	-	-	R/W	R/W	
(50 + (IU[0.47] * 50)) + 6	(50 + (IU[0.47] * 50)) + 5	Use of vertical air flow direction	0: Off 1: On Others: Ignored	R/W	-	-	-	-	-	R/W	-	
(50 + (IU[0.47] * 50)) + 7	(50 + (IU[0.47] * 50)) + 6	Filter-cleaning reminder	0: Filter Alarm Not Present 1: Filter Alarm Present Others: Ignored	R	-	-	R	R	-	R	-	
(50 + (IU[0.47] * 50)) + 8	(50 + (IU[0.47] * 50)) + 7	Canceling the filter-cleaning reminder	0: No Clear Filter Alarm 1: Clear Filter Alarm	W	-	-	W	W	-	W	-	
(50 + (IU[0.47] * 50)) + 9	(50 + (IU[0.47] * 50)) + 8	Set temperature	Celsius value x10 (-41°C to 100°C) Cooling: 18 to 30°C Heating: 16 to 30°C ※ The Nordic models can be controlled at 8 to 30°C for heating.	R/W	-	R/W	-	-	-	R/W	R/W	
(50 + (IU[0.47] * 50)) + 10	(50 + (IU[0.47] * 50)) + 9	Room temperature	Celsius value x10 (-41°C to 100°C)	R	-	R	-	-	-	R	R	
(50 + (IU[0.47] * 50)) + 11	(50 + (IU[0.47] * 50)) + 10	Discharge temperature	Celsius value x10	R	-	R	-	-	-	-	-	
(50 + (IU[0.47] * 50)) + 12	(50 + (IU[0.47] * 50)) + 11	Cooling discharge set temperature	Celsius value x10 8°C to 18°C ※ AHU: 8°C to 25°C	R/W	-	R/W	-	-	-	-	-	
(50 + (IU[0.47] * 50)) + 13	(50 + (IU[0.47] * 50)) + 12	Heating discharge set temperature	Celsius value x10 30°C to 43°C ※ AHU: 18°C to 43°C	R/W	-	R/W	-	-	-	-	-	
(50 + (IU[0.47] * 50)) + 14	(50 + (IU[0.47] * 50)) + 13	Integrated indoor unit error code	0: No Error 100-999: Error Code	R	R	R	R	R	R	R	R	

Installation

Register No.	Modbus PDU address	Signal description	Signal values	Modbus register type (R/W)								Remarks
				Indoor	HE/HT/EHS	AHU kit	ERV	ERV+	CHILLER	FCU	FCU kit	
(50 + (IU[0.47] *50)) + 15	(50 + (IU[0.47] *50)) + 14	Restrictions on the remote control	[Read] 0x0000: No Restriction Others: Restriction [Write] 0x0000: No Restriction 0x6363: Restriction	R/W	R/W	R/W	R/W	R/W	R/W	R/W	R/W	
(50 + (IU[0.47] *50)) + 16	(50 + (IU[0.47] *50)) + 15	Water-in temperature	Celsius value x10	-	R	-	-	-	R	-	-	
(50 + (IU[0.47] *50)) + 17	(50 + (IU[0.47] *50)) + 16	Water-out Temperature	Celsius value x10	-	R	-	-	-	R	-	-	
(50 + (IU[0.47] *50)) + 18	(50 + (IU[0.47] *50)) + 17	MCC water-out temperature	Celsius value x10	-	-	-	-	-	R	-	-	
(50 + (IU[0.47] *50)) + 19	(50 + (IU[0.47] *50)) + 18	Water-out set temperature	Celsius value x10 HE: • Cool: 5°C to 25°C • Heat: 15°C to 50°C HT: • Heat: 25°C to 80°C ※ No Cooling mode in Hydro HT EHS: • Cool: 5°C to 25°C • Heat: 15°C to 55°C CHILLER • Heat/Heat Storage: 25°C to 55°C • Cool/Cool Storate: -10°C to 25°C	-	R/W	-	-	-	R/W	-	-	
(50 + (IU[0.47] *50)) + 20	(50 + (IU[0.47] *50)) + 19	Ventilation on/off	0: Off 1: On Others: Ignored	-	-	-	R/W	R/W	-	-	-	
(50 + (IU[0.47] *50)) + 21	(50 + (IU[0.47] *50)) + 20	Ventilation mode	0: Bypass 1: HeatEx 2: Auto 6: Sleep Others: Ignored	-	-	-	R/W	R/W	-	-	-	
(50 + (IU[0.47] *50)) + 22	(50 + (IU[0.47] *50)) + 21	Ventilation fan speed	0: AUTO 2: Low 3: High 4: Turbo Others: Ignored	-	-	-	R/W	R/W	-	-	-	

Modbus Register Table

Register No.	Modbus PDU address	Signal description	Signal values	Modbus register type (R/W)							Remarks	
				Indoor	HE/HT/EHS	AHU kit	ERV	ERV+	CHILLER	FCU		FCU kit
(50 + (IU[0.47] *50)) + 23	(50 + (IU[0.47] *50)) + 22	Hot water operation on/off	0: HotWater Off 1: HotWater On Others: Ignored	-	R/W	-	-	-	-	-	-	
(50 + (IU[0.47] *50)) + 24	(50 + (IU[0.47] *50)) + 23	Hot water mode	0: Eco 1: Standard 2: Power 3: Force (for the EHS only) Others: Ignored	-	R/W	-	-	-	-	-	-	
(50 + (IU[0.47] *50)) + 25	(50 + (IU[0.47] *50)) + 24	Hot water set temperature	Celsius value x10 HE: 30°C to 75°C HT: 35°C 75°C EHS: 30°C to 70°C	-	R/W	-	-	-	-	-	-	
(50 + (IU[0.47] *50)) + 26	(50 + (IU[0.47] *50)) + 25	Hot water temperature	Celsius value x10	-	R	-	-	-	-	-	-	
(50 + (IU[0.47] *50)) + 27	(50 + (IU[0.47] *50)) + 26	Error information collected by MCC	Error information of slave chiller unit Each bit# indicates the error occurred unit #. (Byte0 0 to 7# unit, Byte1 8 to 15# unit)	-	-	-	-	-	R	-	-	Ex) #0,#2 unit has error, its error code 201 (decimal) : 00 05 00 C9 (hex)
(50 + (IU[0.47] *50)) + 28	(50 + (IU[0.47] *50)) + 27		Error information of slave chiller unit Error code of the lowest # unit among error occurred units. (=same range as error code index 0202)	-	-	-	-	-	-	-	-	
(50 + (IU[0.47] *50)) + 29	(50 + (IU[0.47] *50)) + 28	Quiet control	0: Silence Off 1: Silence On Others: Ignored	-	R/W	-	-	-	-	-	-	
(50 + (IU[0.47] *50)) + 30	(50 + (IU[0.47] *50)) + 29	Away function	0: Outing Off 1: Outing On Others: Ignored	-	R/W	-	-	-	-	-	-	
(50 + (IU[0.47] *50)) + 31	(50 + (IU[0.47] *50)) + 30	Wind-Free function	0: None 9: WindFree Others: Ignored	R/W	-	-	-	-	-	-	-	
(50 + (IU[0.47] *50)) + 32	(50 + (IU[0.47] *50)) + 31	360 air flow direction	Spot: 106 Mid: 85 Wide: 64 Swing: 15 Others: Individual control	R/W	-	-	-	-	-	R/W	-	
(50 + (IU[0.47] *50)) + 33 to (50 + (IU[0.47] *50)) + 50	(50 + (IU[0.47] *50)) + 32 to (50 + (IU[0.47] *50)) + 49	Reserved	-	-	-	-	-	-	-	-	-	

Installation

Memo

Memo

SAMSUNG



DB68-07538A-00

